



TimeSmart
Tips Inside!

Use & Care

G U I D E

Microwave Ovens

A Note to You 2

Microwave Oven
Safety 3-4

Installation
Instructions 5

Getting to Know
Your Microwave
Oven 7

Using Your
Microwave Oven 17

Caring for Your
Microwave Oven 36

Cooking Guide 37

Questions and
Answers 45

Troubleshooting 46

Requesting
Assistance or
Service 48

Index 51

Warranty 52

1-800-253-1301

Call our Consumer Assistance Center
with questions or comments.

MODELS MT6120XE MT9160XE

PART NO. TINSEB151MRR0/4365610 Rev. A

Whirlpool
Home Appliances
10196

A NOTE TO YOU

Thank you for buying a WHIRLPOOL® appliance.

Because your life is getting busier and more complicated, WHIRLPOOL appliances are easy to use, save time, and help you manage your home better. To ensure that you enjoy years of trouble-free operation, we developed this Use and Care Guide. It is full of valuable information about how to operate and maintain your appliance properly and safely. Please read it carefully.

Also, complete and mail the **Product Registration Card** provided with your appliance. The card helps us notify you about any new information on your appliance.

Please record your model's information.

Whenever you call to request service for your appliance, you need to know your complete model number and serial number. You can find this information on the model and serial number plate (see the diagram in the "Getting to Know" section). Also, record the other information shown in the next column.

TimeSmart® TIPS

Look for these tips!

Look for these Time Smart Tips located throughout your Use and Care Guide. They will help you save time and make the most of your new appliance.

Model Number _____

Serial Number _____

Purchase Date _____

Dealer Name _____

Dealer Address _____

Dealer Phone _____

Keep this book and the sales slip together in a safe place for future reference.

Our Consumer Assistance Center number is toll-free.

1-800-253-1301

MICROWAVE OVEN SAFETY

Your safety is important to us.

This guide contains safety symbols and statements. Please pay special attention to these symbols and follow any instructions given. Here is a brief explanation of the use of the symbol.



This symbol alerts you to hazards such as fire, electrical shock, or other injuries.

IMPORTANT SAFETY INSTRUCTIONS

When using electrical appliances basic safety precautions should be followed, including the following:

WARNING: To reduce the risk of burns, electric shock, fire, injury to persons, or exposure to excessive microwave energy:

- Read all instructions before using the microwave oven.
- Read and follow the specific "PRECAUTIONS TO AVOID POSSIBLE EXPOSURE TO EXCESSIVE MICROWAVE ENERGY" found in this section.
- The microwave oven must be grounded. Connect only to properly grounded outlet. See "GROUNDING INSTRUCTIONS" found in the "Installation Instructions" section.
- Install or locate the microwave oven only in accordance with the Installation Instructions.
- Some products such as whole eggs in the shell and sealed containers – for example, closed glass jars – may explode and should not be heated in the microwave oven.
- Use the microwave oven only for its intended use as described in this manual. Do not use corrosive chemicals or vapors in the microwave oven. This type of oven is specifically designed to heat, cook, or dry food. It is not designed for industrial or laboratory use.
- As with any appliance, close supervision is necessary when used by children.
- Do not operate the microwave oven if it has a damaged cord or plug, if it is not working properly, or if it has been damaged or dropped.
- The microwave oven should be serviced only by qualified service personnel. Call an authorized Whirlpool service company for examination, repair, or adjustment.
- Do not cover or block any openings on the microwave oven.
- Do not store the microwave oven outdoors. Do not use the microwave oven near water – for example, near a kitchen sink, in a wet basement, or near a swimming pool, and the like.
- Do not immerse cord or plug in water.
- Keep cord away from heated surfaces.
- Do not let cord hang over edge of table or counter.
- See door surface cleaning instructions in the "Caring for Your Microwave Oven" section.
- To reduce the risk of fire in the oven cavity:
 - Do not overcook food. Carefully attend the microwave oven if paper, plastic, or other combustible materials are placed inside the oven to facilitate cooking.
 - Remove wire twist-ties from paper or plastic bags before placing bag in oven.
 - If materials inside the oven should ignite, keep oven door closed, turn oven off, and disconnect the power cord, or shut off power at the fuse or circuit breaker panel.
 - Do not use the cavity for storage purposes. Do not leave paper products, cooking utensils, or food in the cavity when not in use.
 - Do not mount over a sink.
 - Do not store anything directly on top of the microwave oven when the microwave oven is in operation.

– SAVE THESE INSTRUCTIONS –

PRECAUTIONS TO AVOID POSSIBLE EXPOSURE TO EXCESSIVE MICROWAVE ENERGY...

- (a)** Do not attempt to operate this oven with the door open since open-door operation can result in harmful exposure to microwave energy. It is important not to defeat or tamper with the safety interlocks.
- (b)** Do not place any object between the oven front face and the door or allow soil or cleaner residue to accumulate on sealing surfaces.
- (c)** Do not operate the oven if it is damaged. It is particularly important that the oven door close properly and that there is no damage to the:
 - (1) Door (bent),
 - (2) Hinges and latches (broken or loosened),
 - (3) Door seals and sealing surfaces.
- (d)** The oven should not be adjusted or repaired by anyone except properly qualified service personnel.

INSTALLATION INSTRUCTIONS

Before you begin operating the oven, carefully read the following instructions.

1. **Empty** the microwave oven and **clean** inside it with a soft, damp cloth. **Check** for damage such as a door that isn't lined up correctly, damage around the door, or dents inside the oven or on the exterior. If there is any damage, do not operate the oven until an authorized Whirlpool service technician has checked it and made any needed repairs.

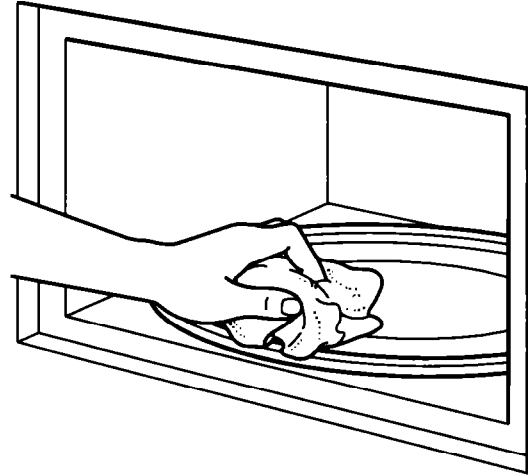

2. **Put** the oven on a cart, counter, table, or shelf that is strong enough to hold the oven and the food and utensils you put in it. **(The control side of the unit is the heavy side. Use care when handling the oven.)** The weight of the oven is about 40 lbs. The microwave oven should be at a temperature above 50°F (10°C) for proper operation.

NOTE: You can build your microwave oven into a wall or cabinet by using one of the trim kits listed in the "Built-in kits" section.

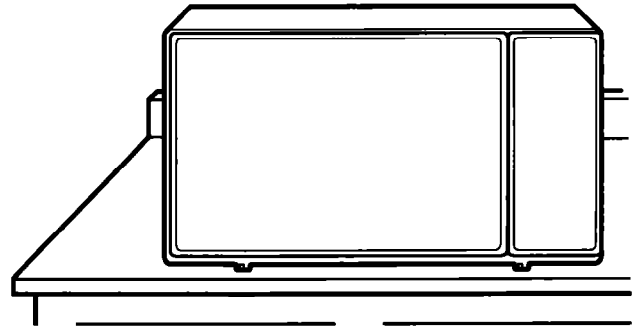

⚠️ WARNING



Fire Hazard

Do not install the oven next to or over a heat source without a UL approved trim kit.

Doing so can result in death, fire, or electrical shock.

NOTE: Do not block the exhaust vents or rear air intake openings. Allow a few inches of space at the back of the oven where the intake openings are located. Blocking the air intake openings and exhaust vents could cause damage to the oven and poor cooking results. Make sure the microwave oven legs are in place to ensure proper airflow. If vents are blocked, a sensitive thermal safety device automatically turns the oven off. The oven will not work until it has cooled enough.

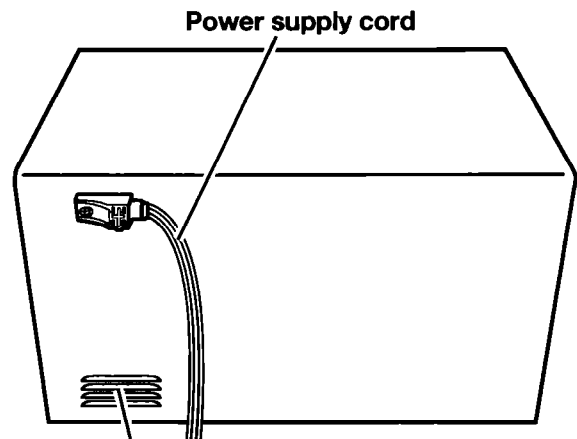

Air intake openings/exhaust vents

ELECTRICAL REQUIREMENTS

Observe all governing codes and ordinances. A 120 Volt, 60 Hz, AC only, 15 amp fused electrical supply is required. (A time-delay fuse is recommended.) It is recommended that a separate circuit serving only this appliance be provided.

⚠ WARNING



Electrical Shock Hazard

Plug into a grounded 3 prong outlet.

Do not remove ground prong.

Do not use an adapter.

Do not use an extension cord.

Failure to follow these instructions can result in death, fire, or electrical shock.

GROUNDING INSTRUCTIONS

For all cord connected appliances:

The microwave oven must be grounded. In the event of an electrical short circuit, grounding reduces the risk of electric shock by providing an escape wire for the electric current. The microwave oven is equipped with a cord having a grounding wire with a grounding plug. The plug must be plugged into an outlet that is properly installed and grounded.

WARNING: Improper use of the grounding can result in a risk of electric shock.

Consult a qualified electrician or serviceman if the grounding instructions are not completely understood, or if doubt exists as to whether the microwave oven is properly grounded.

Do not use an extension cord. If the power supply cord is too short, have a qualified electrician or serviceman install an outlet near the microwave oven.

For a permanently connected appliance:

This appliance must be connected to a grounded, metallic, permanent wiring system, or an equipment grounding conductor should be run with the circuit conductors and connected to the equipment grounding terminal or lead on the appliance.

GETTING TO KNOW YOUR MICROWAVE OVEN

This section discusses the concepts behind microwave cooking. It also shows you the basics you need to know to operate your microwave oven. Please read this information before you use your oven.



⚠ WARNING

Explosion Hazard

Do not store flammable materials such as gasoline near the microwave oven. Doing so can result in death, explosion, fire, or burns.

HOW YOUR MICROWAVE OVEN WORKS

Microwave ovens are safe. Microwave energy is not hot. It causes food to make its own heat, and it's this heat that cooks the food.

Microwaves are like TV waves or light waves. You cannot see them, but you can see what they do.

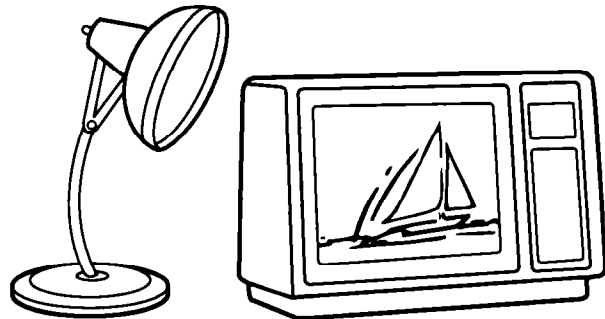

A magnetron in the microwave oven produces microwaves. The microwaves move into the oven where they contact food as it turns on the turntable.

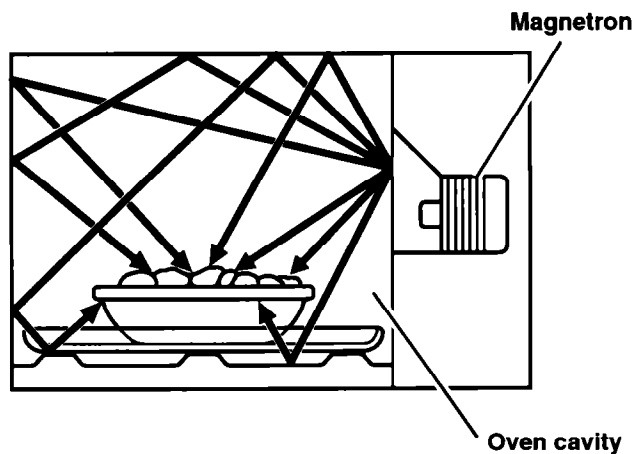

The glass turntable of your microwave oven lets microwaves pass through. Then they bounce off a metal floor, back through the glass turntable, and are absorbed by the food.

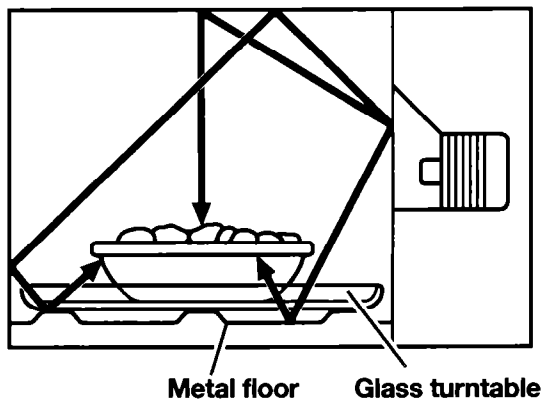

HOW YOUR MICROWAVE OVEN WORKS (CONT.)

Microwaves pass through most glass, paper, and plastics without heating them so food absorbs the energy. Microwaves bounce off metal containers so food does not absorb the energy.

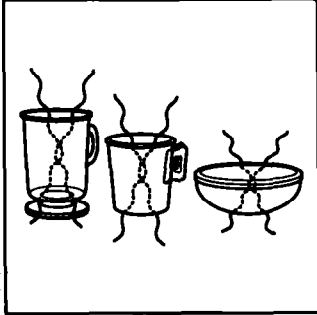

Microwaves may not reach the center of a roast. The heat spreads to the center from the outer, cooked areas just as in regular oven cooking. This is one of the reasons for letting some foods (for example, roasts or baked potatoes) stand for a while after cooking, or for stirring some foods during the cooking time.

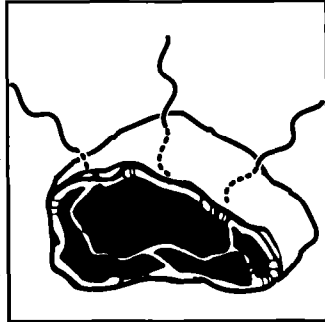

The microwaves disturb water molecules in the food. As the molecules bounce around bumping into each other, heat is made, like rubbing your hands together. This is the heat that does the cooking.

Time-Saver* TIPS

For the best cooking results

- Always cook food for the shortest cooking time recommended. Check to see how the food is cooking. If needed, touch the add minute pad while the oven is operating or after the cooking cycle is over (see the "Using add minute" section).
- Stir, turn over, or rearrange the food being cooked about halfway through the cooking time for all recipes. This will help make sure the food is evenly cooked.
- If you do not have a cover for a dish, use wax paper, or microwave-approved paper towels or plastic wrap. Remember to turn back a corner of the plastic wrap to vent steam during cooking.

NOTE: Do not deep fry in the oven. Microwavable utensils are not suitable and it is difficult to maintain appropriate deep frying temperatures.

RADIO INTERFERENCE

Using your microwave oven may cause interference to your radio, TV, or similar equipment. When there is interference, you can reduce it or remove it by:

- **Cleaning** the door and sealing surfaces of the oven.
- **Adjusting** the receiving antenna of the radio or television.
- **Moving** the receiver away from the microwave oven.
- **Plugging** the microwave oven into a different outlet so that the microwave oven and receiver are on different branch circuits.

TESTING YOUR MICROWAVE OVEN

To test the oven put about 1 cup of cold water in a glass container in the oven. Close the door. Make sure it latches. Follow the directions in the "Cooking at high cook power" section to set the oven to cook for 2 minutes. When the time is up, the water should be heated.



TESTING YOUR DINNERWARE OR COOKWARE

Test dinnerware or cookware before using. To test a dish for safe use, put it into the oven with a cup of water beside it. Cook at 100% cook power for one minute. **If the dish gets hot and water stays cool, do not use it.** Some dishes (melamine, some ceramic dinnerware, etc.) absorb microwave energy, becoming too hot to handle and slowing cooking times. Cooking in metal containers not designed for microwave use could damage the oven, as could containers with hidden metal (twist-ties, foil lining, staples, metallic glaze or trim).

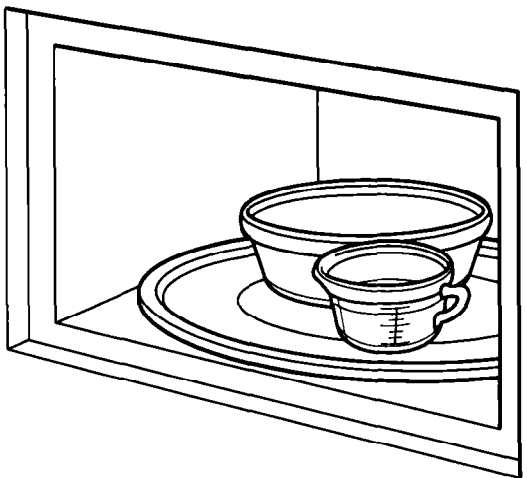

OPERATING SAFETY PRECAUTIONS

Never cook or reheat a whole egg inside the shell. Steam buildup in whole eggs may cause them to burst and burn you, and possibly damage the oven. **Slice hard-boiled eggs before heating.** In rare cases, poached eggs have been known to explode. **Cover** poached eggs and

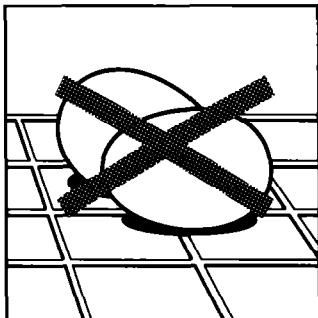

allow a standing time of one minute before cutting into them.

For best results, stir any liquid several times before heating or reheating. Liquids heated in certain containers (especially containers shaped like cylinders) may become overheated. The liquid may splash out with a loud noise during or after heating or when adding ingredients

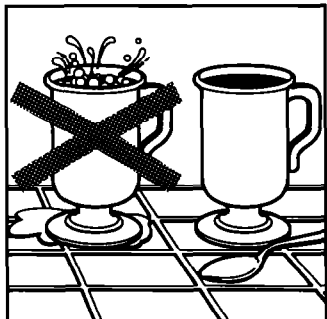

(coffee granules, tea bags, etc.). This can harm the oven and possibly injure someone.

Never lean on the door or allow a child to swing on it when the door is open. Injury could result.

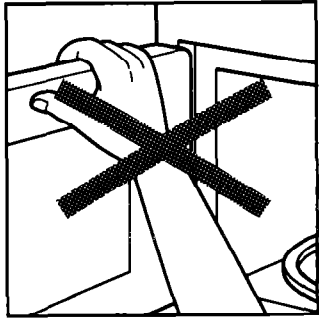

Use hot pads. Microwave energy does not heat containers, but the heat from the food can make the container hot.

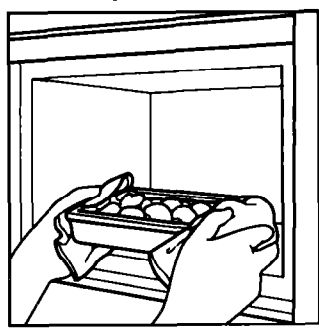

OPERATING SAFETY PRECAUTIONS (CONT.)

Do not overcook potatoes. Fire could result. At the end of the recommended cooking time, potatoes should be slightly firm because they will continue cooking during standing time. **After microwaving, wrap potatoes in foil and set aside for 5 minutes.** They will finish cooking while standing.

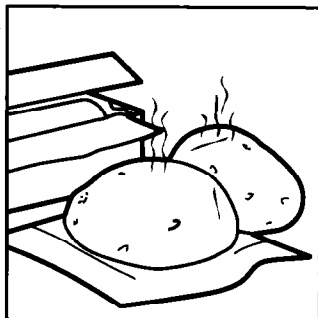

Do not start a microwave oven when it is empty. Product life may be shortened. If you practice programming the oven, **put a container of water in the oven.** It is normal for the oven door to look wavy after the oven has been running for a while.

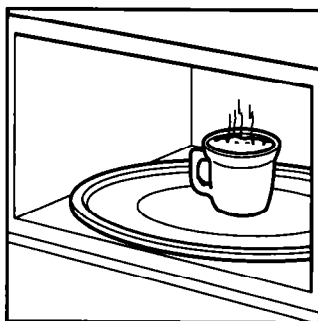

Do not use newspaper or other printed paper in the oven. Fire could result. **Do not dry flowers, fruit, herbs, wood, paper, gourds, or clothes in the oven.** Fire could result.

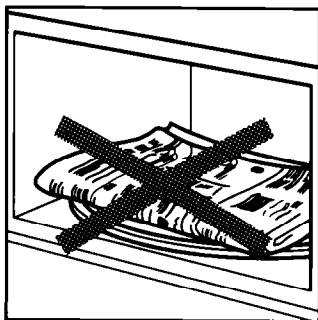

Do not try to melt paraffin wax in the oven. Paraffin wax will not melt in a microwave oven because it allows microwaves to pass through it.

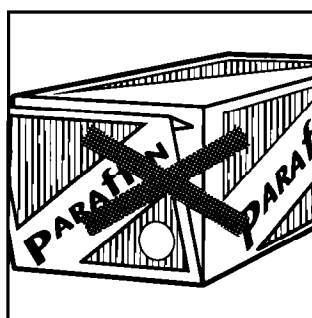

Do not operate the microwave oven unless the glass turntable is securely in place and can rotate freely. The turntable can rotate in either direction. **Make sure** the support base is all the way on the shaft in the oven cavity floor. **Make sure** the support rollers are completely inside the center circle of the turntable; this will let the turntable rotate properly.

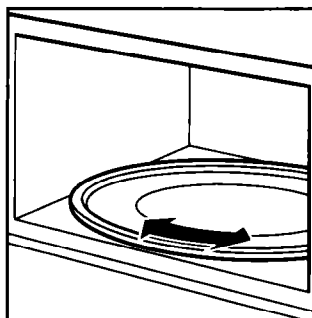

Make sure the turntable is correct-side up in the oven. **Carefully place** the cookware on your turntable to avoid possibly breaking it.

Handle your turntable with care when removing it from the oven to avoid possibly breaking it. If your turntable cracks or breaks, contact your Whirlpool dealer for a replacement.

When you use a browning dish, the browning dish bottom must be at least $\frac{3}{16}$ inch above the turntable. Follow the directions supplied with the browning dish.

ELECTRICAL CONNECTION

If your electric power line or outlet voltage is less than 110 volts, cooking times may be longer. Have a qualified electrician check your electrical system.

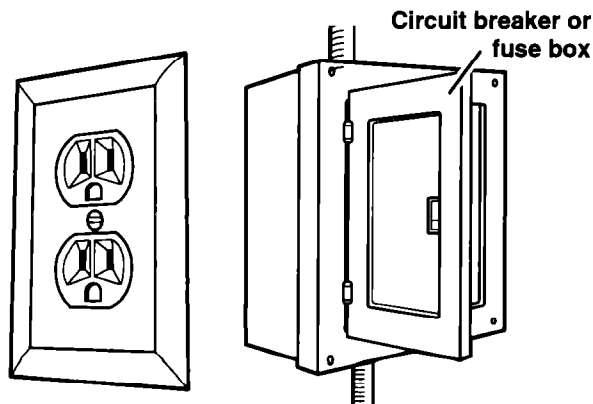

MICROWAVE OVEN FEATURES

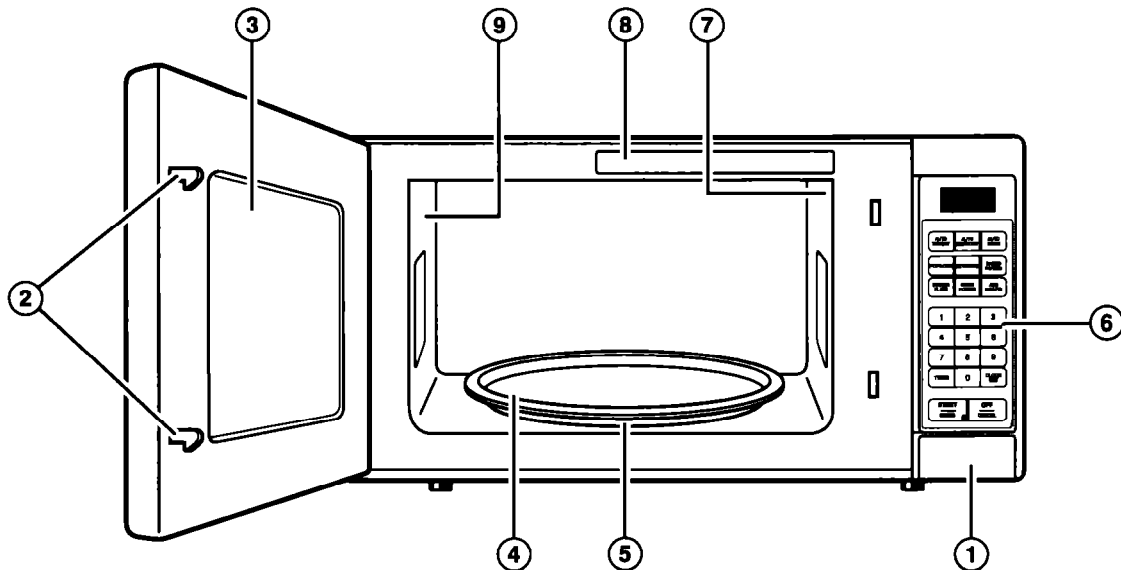

Your microwave oven is designed to make your cooking experience as enjoyable and productive as possible. To help get you up and running quickly, the following is a list of the oven's basic features:

- 1. One-Touch Door Open Button.** Push this button to open the door.
- 2. Door Safety Lock System.** The oven will not work unless the door is securely closed.
- 3. Window with Metal Shield.** The shield prevents microwaves from escaping. It is designed as a screen to allow you to view food as it cooks.
- 4. Glass Turntable.** This turntable turns food as it cooks for more even cooking. It must be in the oven during operation for best cooking results. See pages 7, 10, 36, and 45 for more details.

5. Removable Turntable Support (under turntable).

6. Control Panel. Touch pads on this panel to perform all functions. See pages 12-13 for more information.

7. Light. The light automatically turns on when the door is opened or when the oven is running.

8. Cooking Guide Label.

9. Model and Serial Number Plate.

NOTE: This microwave oven is available in both Designer Black™ and Designer White™ models.

CONTROL PANEL FEATURES

Your microwave oven control panel lets you choose the cooking function you want quickly and easily. All you have to do is touch the necessary command and number pads located on the control panel. The following is a list of all the command and number pads located on the control panel. For more information, see pages 14-35.

- 1. Display.** This display includes a clock and indicators to tell you the time of day, cooking time settings, and cooking functions you chose.
- 2. AUTO REHEAT.** Touch this pad to reheat food, without needing to enter a cook power or time. See page 33 for more information.
- 3. AUTO DEFROST.** Touch this pad to thaw frozen food by weight. See page 25 for more information.
- 4. AUTO COOK.** Touch this pad to cook common microwave-prepared foods, without needing to enter a cook power or time. See page 23 for more information.
- 5. POPCORN.** Touch this pad to pop popcorn, without needing to enter a cook power or time. See page 28 for more information.
- 6. BEVERAGE.** Touch this pad to reheat a beverage, without needing to enter a cook power or time. See page 30 for more information.
- 7. BAKED POTATO.** Touch this pad to bake potatoes, without needing to enter a cook power or time. See page 32 for more information.
- 8. DINNER PLATE.** Touch this pad to reheat a dinner-sized plate of refrigerated food, without needing to enter a cook power or time. See page 31 for more information.
- 9. ADD MINUTE.** Touch this pad to cook for one minute at 100% cook power or to add an extra minute to your cooking cycle. See page 34 for more information.
- 10. COOK POWER.** Touch this pad, after the cook time has been set, followed by a number pad to set the amount of microwave energy released to cook the food. The higher the number, the higher the power or faster the "cooking speed." See page 18 for more information. See the "Microwave cooking chart" on page 38 for specific cook powers to use for the foods you are cooking.
- 11. Number pads.** Touch number pads to enter cooking times, cook powers, quantities, or weights.
- 12. TIMER.** Touch this pad to set the minute timer. See page 16 for more information.

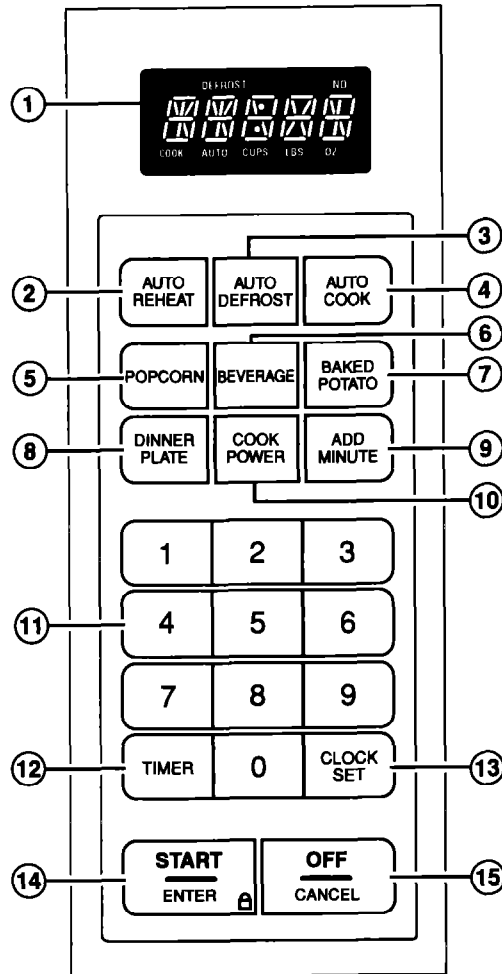

CONTROL PANEL FEATURES (CONT.)

- 13. CLOCK SET.** Touch this pad to enter the correct time of day. See page 14 for more information.
- 14. START/ENTER.** Touch this pad to start a function you have set.
- 15. OFF/CANCEL.** Touch this pad to erase an incorrect command or to cancel a program during cooking. This pad will not erase the time of day.

NOTE: If you try to enter unacceptable instructions, "ERROR" will appear on the display. Touch the off/cancel pad and re-enter the instructions.

Audible signals

Your microwave oven comes with audible signals that can guide you when setting and using your oven:

- A programming tone will sound each time you touch a pad.
- A single long tone signals the end of a cooking cycle or minute timer function.
- To cancel the tones, touch number pad 1 for 4 seconds. To turn the tones back on, touch number pad 1 again for 4 seconds.

Interrupting cooking

You can stop the oven during a cycle by opening the door. The oven stops heating and the fan stops, but the light stays on. To restart cooking, close the door and

TOUCH



If you do not want to continue cooking:

- Close the door and the light goes off.

OR

- **TOUCH**



NOTE: Before setting a function, touch the off/cancel pad to make sure no other function is on.

Using the safety lock

The safety lock locks the control panel so others cannot use the microwave when you do not want them to.

To lock the control panel:

TOUCH



for 4 seconds

"LOCK" will appear on the display if a pad is touched.

To unlock the control panel:

TOUCH



for 4 seconds

Using the learning feature

You can set your microwave oven to display your commands as you enter them without turning the oven on. This feature helps you learn to use your oven without actually cooking food.

To set the learning feature:

TOUCH

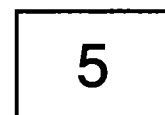

for 5 seconds

"DEMO" will appear on the display.

To cancel the learning feature:

TOUCH

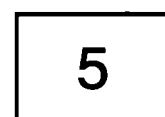

for 5 seconds

BUILT-IN KITS

You can build in your microwave oven by using one of the following trim kits. These kits are available from your Whirlpool Dealer. If your dealer does not stock the kit you can order it, by kit part number, by calling **1-800-253-1301** and following the instructions and telephone prompts you hear.

SIZE	COLOR	KIT MODEL NO.	FOR INSTALLATION OVER WHIRLPOOL OVEN MODEL
For Model MT6120XE			
24"	Black	MK6124XEB	RBS240PDB RBS245PDB SB130PEDB SB160PEEB
27"	Black	MK6127XEB	RBS270PDB RBS275PDB RBS277PDB SB130PEDB SB160PEEB
30"	Black	MK6120XEB	RBS305PDB RBS307PDB
24"	White	MK6124XEQ	RBS245PDQ SB160PEEQ
27"	White	MK6127XEQ	RBS275PDQ RBS277PDQ SB160PEEQ
30"	White	MK6120XEQ	RBS305PDQ RBS307PDQ
For Model MT9160XE			
27"	Black	MK9167XEB	RBS270PDB RBS275PDB RBS277PDB SB130PEDB SB160PEEB
30"	Black	MK9160XEB	RBS305PDB RBS307PDB
27"	White	MK9167XEQ	RBS275PDQ RBS277PDQ SB160PEEQ
30"	White	MK9160XEQ	RBS305PDQ RBS307PDQ

SETTING THE CLOCK

When you first plug in your microwave oven, the display flashes "88:88." If the electric power ever goes off, the display will again flash all 8's when the power comes back on.

NOTES:

- You can cook without setting the clock, but the display will not show the correct time of day after cooking.

- To reset the clock, touch the clock set pad. A "0" will show on the display. Continue to set the clock as shown on the next page.
- If you have touched in an incorrect time, such as 12:65, "ERROR" will show on the display. Touch the off/cancel pad, then touch the clock set pad and start over.

SETTING THE CLOCK (CONT.)

1. Choose the setting.

TOUCH

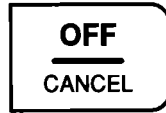

YOU SEE

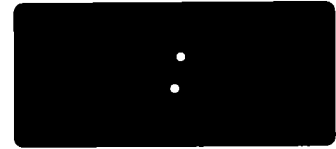

TOUCH



YOU SEE



2. Enter the time of day.

Example for 3:25:

TOUCH

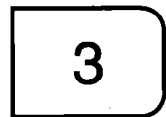

YOU SEE



3. Complete your entry.

TOUCH



YOU SEE



OR



USING THE MINUTE TIMER

You can use your microwave oven as a kitchen timer. Use the minute timer for timing up to 99 minutes, 99 seconds.

NOTES:

- To see the time of day while the minute timer is counting down, touch the clock set pad.
- If you want to use other command pads while the minute timer is counting down, touch the off/cancel pad to cancel the minute timer.

1. Enter the time to be counted down.

Example for 3 minutes:

TOUCH



YOU SEE



2. Start the countdown.

TOUCH



YOU SEE



(display counts down set time)

3. When the set time ends, a long tone will sound.

YOU SEE



The display will show the time of day when you touch the off/cancel pad.

TOUCH



YOU SEE



(time of day)

USING YOUR MICROWAVE OVEN

This section gives you instructions for operating each function. Please read these instructions carefully.

COOKING AT HIGH COOK POWER

NOTE: If you use full power for more than 3 hours, the oven will stop on its own.

1. Put your food in the oven and close the door.

2. Set the cooking time.

Example for 1 minute, 30 seconds:

TOUCH

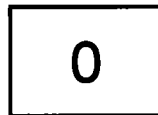

YOU SEE

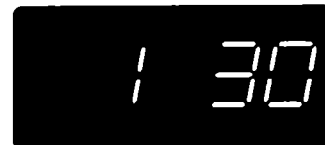

3. Start the oven.

TOUCH



YOU SEE

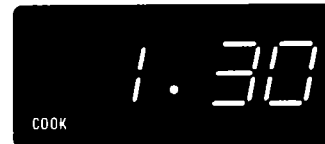

(display counts down cooking time)

4. When the cooking time ends, a long tone will sound and the oven will stop.

YOU SEE

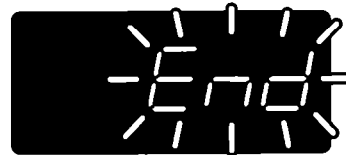

The display will show the time of day when you open the door.

YOU SEE



(time of day)

COOKING AT DIFFERENT COOK POWERS

For best results, some recipes call for different cook powers. The lower the cook power, the slower the cooking. Each number pad also stands for a different percentage of cook power. Many microwave cookbook recipes tell you by number, percent, or name which cook power to use.

The following chart gives the percentage of cook power each number pad stands for, and the cook power name usually used. It also tells you when to use each cook power. Follow recipe or food package instructions if available.

NOTE: Refer to a reliable cookbook for cooking times.

COOK POWER	NAME	WHEN TO USE IT
100% of full power	High	<ul style="list-style-type: none"> ● Quick heating many convenience foods and foods with high water content, such as soups and beverages ● Cooking small tender pieces of meat, ground meat, poultry pieces, fish fillets, and vegetables
9=90% of full power		<ul style="list-style-type: none"> ● Heating cream soups
8=80% of full power		<ul style="list-style-type: none"> ● Heating rice, pasta, or casseroles
7=70% of full power	Medium-High	<ul style="list-style-type: none"> ● Cooking and heating foods that need a cook power lower than high (for example, whole fish and meat loaf) or when food is cooking too fast ● Reheating a single serving of food
6=60% of full power		<ul style="list-style-type: none"> ● Cooking requiring special care, such as cheese and egg dishes, pudding, and custards ● Finishing cooking casseroles
5=50% of full power	Medium	<ul style="list-style-type: none"> ● Cooking ham, whole poultry, and pot roasts ● Melting chocolate
4=40% of full power		<ul style="list-style-type: none"> ● Simmering stews ● Heating pastries
3=30% of full power	Medium-Low, Defrost	<ul style="list-style-type: none"> ● Defrosting foods, such as bread, fish, meats, poultry, and precooked foods
2=20% of full power		<ul style="list-style-type: none"> ● Softening butter, cheese, and ice cream
1=10% of full power	Low	<ul style="list-style-type: none"> ● Keeping food warm ● Taking chill out of fruit

COOKING AT DIFFERENT COOK POWERS (CONT.)

1. Put your food in the oven and close the door.

2. Set the cooking time.

Example for 7 minutes, 30 seconds:

TOUCH

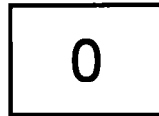

YOU SEE

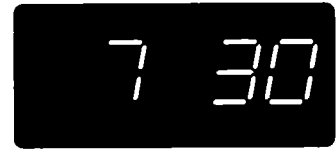

3. Set the cook power.

Example for 50% cook power:

TOUCH



YOU SEE



TOUCH



YOU SEE

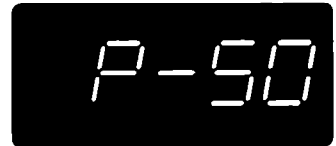

continued on next page

COOKING AT DIFFERENT COOK POWERS (CONT.)

4. Set the hold time (optional).

You can hold your food in the oven for a specific amount of time after cooking. Set the hold time by entering the time and a cook power of "0."

Example for a 5-minute hold time:

TOUCH

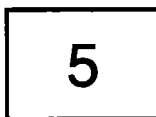

YOU SEE

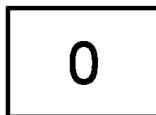
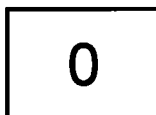

TOUCH



YOU SEE



TOUCH

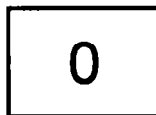

YOU SEE



5. Start the oven.

TOUCH



YOU SEE

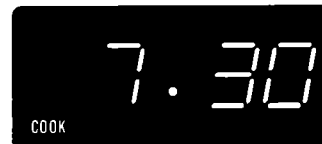

(display counts down cooking time)

6. When the cooking time ends, a long tone will sound and the oven will stop.

YOU SEE

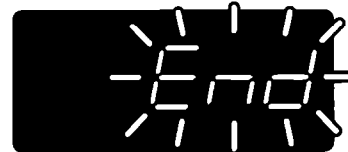

The display will show the time of day when you open the door.

YOU SEE



(time of day)

COOKING IN STAGES

For best results, some recipes call for one cook power for a certain length of time, and another cook power for another length of time. Your oven can be set to change from one to another automatically.

1. Put your food in the oven and close the door.

2. Set the cooking time for the first cycle.

Example for 7 minutes, 30 seconds:

TOUCH

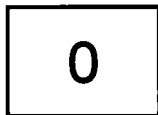
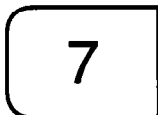

YOU SEE

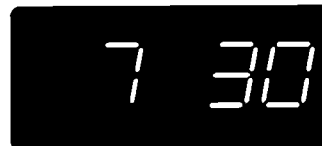

3. Set the cook power for the first cycle.

Example for 50% cook power:

TOUCH



YOU SEE

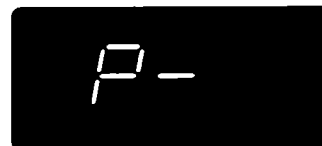

TOUCH

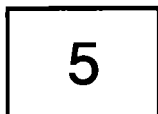

YOU SEE



4. Set the cooking time for the second cycle.

Example for 3 minutes, 25 seconds:

TOUCH



YOU SEE



continued on next page

COOKING IN STAGES (CONT.)

- 5.** Set the cook power for the second cycle.
To cook at full (100%) power, skip to Step 6.
To cook at another cook power (example for 60% cook power):

TOUCH



YOU SEE



TOUCH

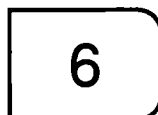

YOU SEE



- 6.** Start the oven.

TOUCH



YOU SEE

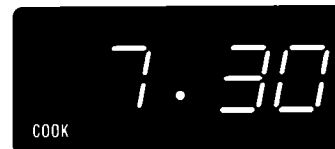

(display counts down cooking time in each cycle)

- 7.** When the cooking time ends, a long tone will sound and the oven will stop.

YOU SEE

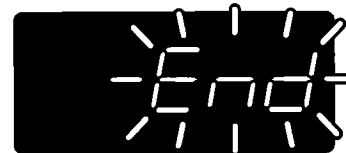

The display will show the time of day when you open the door.

YOU SEE



(time of day)

Changing or adding instructions

You can change times or cook powers, or add cycles any time before or after touching the start/enter pad:

- Touch the off/cancel pad twice.
- Enter your new instructions.

USING AUTO COOK

Cooking with AUTO COOK lets you cook common microwave-prepared foods without needing to set times and cook powers. AUTO COOK has preset times and cook powers for six major food categories: Fresh Vegetables, Frozen Vegetables, Rice, Ground Meat, Fish Fillets, and Frozen Main Dish.

All you do is touch the auto cook pad, then enter the amount being cooked. Your microwave oven does the rest.

NOTE: If you want to cook by entering a time and cook power, see the "Microwave cooking chart" in the "Cooking Guide" section.

1. Put your food in the oven and close the door.

2. Choose the setting.

Example for Setting 2 (Frozen Vegetables):

NOTE: See the "Auto cook chart" or the Cook Guide Label on the frame behind the door for the food settings available.

TOUCH



twice

YOU SEE



3. Enter the amount of items to be heated.

Example for 3 items:

TOUCH



YOU SEE



4. Start the oven.

TOUCH



YOU SEE



(display counts down cooking time)

5. When the cooking time ends, a long tone will sound and the oven will stop.

NOTE: Different words will appear on the display depending upon which food you are cooking.

YOU SEE



(example)

YOU SEE



(time of day)

The display will show the time of day when you open the door.

AUTO COOK CHART

SETTING	TOUCH AUTO COOK PAD	QUANTITY		PROCEDURE
		MT6120XE	MT9160XE	
Fresh Vegetables	once	1-6 cups	1-8 cups	For beans, carrots, corn, and peas add 1 table-spoon of water per cup. For broccoli, brussels sprouts, cabbage, and cauliflower cook immediately after washing with no additional water. If you like tender, crisp vegetables, double or triple the quantity per setting. For example, use 2 or 3 cups of zucchini, but touch number pad 1 for one cup. After cooking, remove from the oven, stir, cover, and let stand 3 to 5 minutes before serving.
Frozen Vegetables	twice	1-6 cups	1-8 cups	Cover with lid or plastic wrap. Let stand 3 minutes, covered. NOTE: To select an amount when cooking a 10 oz package of frozen vegetables (this equals about 1½ cups), touch “1” for 1 cup of “tender crisp” vegetables (you cannot enter ½ cup amounts) or touch “2” for two cups of vegetables more fully cooked.
Rice	3 times	0.5-2 cups	0.5-2 cups	Use this setting to cook rice by selecting the number pads. For ½ cup, touch 5; for 1 cup, touch 1 and 0; for 1.5 cups, touch 1 and 5; and for 2 cups touch 2 and 0. Place rice into a deep casserole. Cover with a lid or plastic wrap. After cooking, stir, cover and let stand 3-5 minutes or until all liquid has been absorbed.
Ground Meat	4 times	0.3-2.0 lbs	0.3-2.0 lbs	Use this setting to cook ground beef or turkey as patties or in a casserole to be added to other ingredients. Place patties on a microwave-safe rack and cover with wax paper. Place ground meat in a casserole and cover with wax paper or plastic wrap. When oven stops and “TURN OVER” is displayed, turn patties over or stir meat in casserole to break large pieces. Re-cover and touch the start/enter pad. After cooking, let stand, covered, for 2-3 minutes.
Fish Fillets	5 times	0.5-2.0 lbs	0.5-2.0 lbs	Use this setting for fresh or defrosted fish fillets. Arrange in a pie plate or shallow casserole in a single layer. Tuck thin ends under to prevent overcooking. Cover with vented plastic wrap. After cooking, let stand, covered, for 1-3 minutes.
Frozen Main Dish	6 times	6-8 oz 9-11 oz 12-14 oz 15-17 oz	6-8 oz 9-11 oz 12-14 oz 15-17 oz	Use this pad for frozen convenience foods. It will give you satisfactory results for most brands. Remove lid from container and place frozen main dish in oven. Touch AUTO COOK Pad 6 times for frozen main dish. Then enter the food’s weight by touching the number pads and touch START/ENTER. Heat only one main dish at a time.

NOTE: If you enter an amount not shown in the chart above, “ERROR” will appear. AUTO COOK will only operate with the amounts shown.

USING AUTO DEFROST

Your microwave oven automatically defrosts a variety of common meats at preset cook powers for preset times. The 3-stage AUTO DEFROST cycle defrosts ground meat, steaks, chops, fish, and chicken pieces. All you do is touch AUTO DEFROST, then enter the weight of the items being defrosted. Your microwave oven does the rest.

- If "ERROR" appears on the display, touch the off/cancel pad and start over.
- To defrost items not listed in AUTO DEFROST, use a cooking time and 30% cook power. Let the food stand after defrosting. Refer to a reliable cookbook for defrosting information.

NOTES:

- If you want to change the defrost time after choosing AUTO DEFROST, see the "Adding or subtracting cooking time" section.

1. Put your frozen food in the oven and close the door.

2. Touch the auto defrost pad.

Example for Ground Meat (Setting 1):

NOTE: See the "Auto defrost chart" for the settings available.

TOUCH



once

YOU SEE



3. Enter the food's weight.

Touch number pads.

Example for 1.0 lbs:

TOUCH

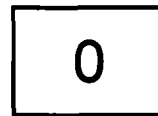

YOU SEE



4. Start the oven.

TOUCH



YOU SEE



(example: display counts down defrosting time in first stage)

continued on next page

USING AUTO DEFROST (CONT.)

5. After the first stage is over, four tones will sound and the oven will stop.

Open the door, pull apart your meat, and remove the defrosted portion from the oven.

YOU SEE

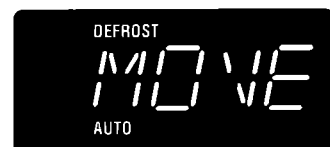

6. Close the door.

TimeSmart® TIPS

For even, complete defrosting

- The shape of the package affects how quickly food will defrost. Shallow packages will defrost more quickly than a deep block.
- As food begins to defrost, separate the pieces. Separated pieces defrost more easily.
- Use small pieces of aluminum foil to shield parts of food such as chicken wings, leg tips, fish tails, or areas that start to get warm. Make sure the foil does not touch the sides, top, or bottom of the oven. The foil can damage the oven lining.

YOU SEE

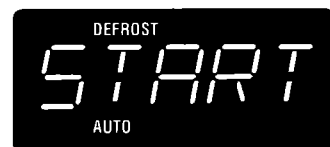

USING AUTO DEFROST (CONT.)

7. Restart the oven.

NOTE: The oven stops again after the second stage to let you check your food.

TOUCH



YOU SEE



(example: display counts down defrosting time in second stage)

8. When the defrosting time ends, a long tone will sound and the oven will stop.

YOU SEE



YOU SEE



(time of day)

The display will show the time of day when you open the door.

AUTO DEFROST CHART

SETTING	TOUCH AUTO DEFROST PAD	QUANTITY	PROCEDURE
Ground Meat	once	0.5-3.0 lbs.	Remove any thawed parts after each stage. Stand, 5-10 minutes.
Steaks/Chops/Fish	twice	0.5-4.0 lbs.	After the 1st stage, turn over and shield any warm portions with aluminum foil. After the 2nd stage, shield any warm portions with aluminum foil. Cover. Stand, 10-20 minutes.
Chicken Pieces	3 times	0.5-3.0 lbs.	After the 1st stage, pull apart and rearrange. After the 2nd stage, if there are warm or thawed portions, rearrange and cover edges. Stand, 10-20 minutes.

NOTE: To defrost items not listed in AUTO DEFROST, use 30% cook power.

DEFROSTING TIPS

- When using AUTO DEFROST, you need to enter the net weight (the weight of the food minus the container). Enter the weight to the nearest 1/10 lb.
- Only use AUTO DEFROST for raw food. AUTO DEFROST gives best results when the food to be thawed is completely frozen. If the food is partially defrosted, always set a lower food weight (for a shorter defrosting time) to prevent cooking the food.
- For better results, a preset standing time is included in the defrosting time. This may make the defrosting time seem longer than expected. (For more information on standing time, see the "Microwave cooking tips" in the "Cooking Guide" section.)

USING POPCORN

POPCORN lets you pop commercially packaged microwave popcorn by touching just one pad. Pop only one package at a time. If you are using a microwave popcorn popper, follow the manufacturer's instructions. You can set your microwave oven to pop different types of popcorn in different size bags. You specify the setting by the number of times you touch POPCORN.

To correctly set your microwave oven, follow this chart:

BAG SIZE (OZ)	3.5	3.0 or 3.5	1.75	1.5 or 1.75
POPCORN TYPE	Reg Size	Light Reg Size	Snack Size	Light Snack Size
TOUCH POPCORN	once	twice	3 times	4 times

TimeSaver TIPS

Popcorn brands make a difference

How well your popcorn pops will depend on the brand of popcorn and how much fat it has in it. Try several brands to decide which pops the best. For best results, use fresh bags of popcorn.

NOTES:

- Before using POPCORN, be sure the time of day is showing on the display. If the time of day is not on the display, touch the off/cancel pad once or twice.
- If you want to change the popping time after choosing POPCORN, see the "Adding or subtracting cooking time" section.

⚠ WARNING



Fire Hazard

- Do not repop unpopped kernels.
- Do not reuse popcorn bags.
- Doing so can result in death, fire, or burns.

USING POPCORN (CONT.)

1. Place the bag in the center of the turntable and close the door.

2. Touch the popcorn pad.
Example for 3.5 oz regular bags:

TOUCH



once

YOU SEE



After 2 seconds:

YOU SEE



(display counts down popping time)

3. When the popping time ends, a long tone will sound and the oven will stop.

YOU SEE

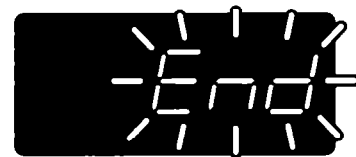

The display will show the time of day when you open the door.

YOU SEE



(time of day)

USING BEVERAGE

BEVERAGE lets you heat a beverage by touching just one pad.

NOTES:

- Before using BEVERAGE, be sure the time of day is showing on the display. If the time of day is not on the display, touch the off/cancel pad once or twice to bring it up.
- If you want to change the heating time after choosing BEVERAGE, see the "Adding or subtracting cooking time" section.

1. Place a cup of a beverage in the oven and close the door.

2. Choose the size of the beverage.

Each time you touch the beverage pad, the displayed size goes up by 0.5 cup, up to 2.0 cups.

To heat a half cup of a beverage:

TOUCH



once

YOU SEE



(display counts down heating time)

3. When the heating time ends, a long tone will sound and the oven will stop.

Remove the beverage from the oven and gently stir it to make temperature even.

The display will show the time of day when you open the door.

YOU SEE



YOU SEE



(time of day)

USING DINNER PLATE

DINNER PLATE lets you reheat a dinner-size plate of refrigerated food.

NOTES:

- Before using DINNER PLATE, be sure the time of day is showing on the display. If the time of day is not on the display, touch the off/cancel pad once or twice to bring it up.
- If you want to change the heating time after choosing DINNER PLATE, see the "Adding or subtracting cooking time" section.

1. Place a plate of food in the oven and close the door.

TimeSaver® TIPS

Preparing your plate

Place meat and bulky vegetables to the outside of the plate. Cover the plate with wax paper.

2. Choose the size of the dinner plate. Touch the dinner plate pad once for regular, twice for large, 3 times for small.

To heat a small dinner plate:

After 3 seconds:

TOUCH



3 times

YOU SEE



YOU SEE



(display counts down heating time)

3. When the heating time ends, a long tone will sound and the oven will stop.

The display will show the time of day when you open the door.

YOU SEE



YOU SEE



(time of day)

USING BAKED POTATO

BAKED POTATO lets you bake 1-6 potatoes (for Model MT6120XE) or 1-8 potatoes (for Model MT9160XE) by touching just one pad.

NOTES:

- Before using BAKED POTATO, be sure the time of day is showing on the display. If the time of day is not on the display, touch the off/cancel pad once or twice to bring it up.
- If you want to change the cooking time after choosing BAKED POTATO, see the "Adding or subtracting cooking time" section.

1. Place pierced potato(es) in the oven and close the door.

2. Choose the number of potatoes. Touch the baked potato pad once for each potato.

Example for 4 potatoes:

After 3 seconds:

TOUCH



4 times

YOU SEE

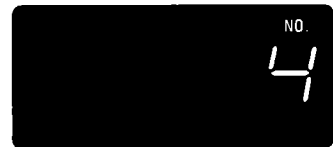

YOU SEE



(display counts down cooking time)

3. When the cooking time ends, a long tone will sound and the oven will stop.

The display will show the time of day when you open the door.

YOU SEE



YOU SEE



(time of day)

TimeSaver™ TIPS

For a better baked potato

Before baking, remember to pierce the potato(es) with a fork several times. After cooking, let the potato(es) stand 5 minutes wrapped in foil.

USING AUTO REHEAT

AUTO REHEAT lets you reheat food without entering a cooking time or cook power. Choose from five settings preset for different foods and enter the quantity to be cooked. See the "Auto reheat chart" for the settings available.

NOTE: If you want to reheat by entering a time and cook power, see the "Reheating chart" in the "Cooking Guide" section.

1. Put your food in the oven and close the door.

2. Choose the reheat cycle you want.

Example for Setting 1 (Pasta/Casserole):

TOUCH



once

YOU SEE

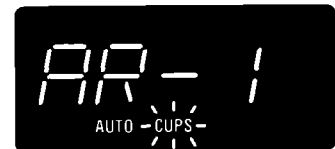

3. Enter the quantity (1-6 for Model MT6120XE or 1-8 for Model MT9160XE).

Example for 1 cup:

TOUCH



YOU SEE



4. Start the oven.

TOUCH



YOU SEE



5. When the reheating time ends, a long tone will sound and the oven will stop.

YOU SEE



The display will show the time of day when you open the door.

YOU SEE



(time of day)

AUTO REHEAT CHART

SETTING	TOUCH AUTO REHEAT PAD	QUANTITY	
		Model MT6120XE	Model MT9160XE
Pasta/Casserole	once	1-6 cups	1-8 cups
Roll/Muffin, Fresh	twice	1-8 pieces	1-10 pieces
Roll/Muffin, Frozen	3 times	1-8 pieces	1-10 pieces
Pizza Slice	4 times	1-6 slices	1-6 slices
Soup	5 times	1-4 cups	1-6 cups

USING ADD MINUTE

ADD MINUTE lets you cook food for one minute at 100% cook power or add an extra minute to your cooking cycle. You can also use it to extend cooking time in one-minute amounts.

NOTES:

- To extend cooking time while you are cooking, touch the add minute pad once for each extra minute.
- You can enter ADD MINUTE only after closing the door, after touching the off/cancel pad, or during cooking.

- If you touch the add minute pad during cooking, the oven will cook at the cook power you have set. If you touch the add minute pad after cooking, the oven will cook at 100% cook power.
- You can use ADD MINUTE only with timed cooking.
- You can only use ADD MINUTE to start the oven if no other cooking function is running.

1. Make sure your food is in the oven.

2. Touch the add minute pad.

Example when cooking for one minute:

TOUCH



once

YOU SEE



Example when increasing the time during cooking for 7 minutes, 16 seconds:

TOUCH



once

YOU SEE

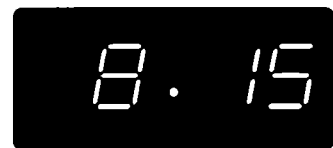

again



USING ADD MINUTE (CONT.)

3. When the cooking time ends, a long tone will sound and the oven will stop.

The display will show the time of day when you open the door.

YOU SEE

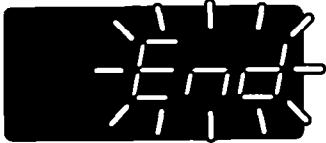

YOU SEE



(time of day)

ADDING OR SUBTRACTING COOKING TIME

If a preset cooking time is too long or too short, you can increase or decrease the cooking time by 7% after choosing the function.

NOTE: When changing cooking time for POPCORN, BEVERAGE, BAKED POTATO, or DINNER PLATE, you must touch the COOK POWER Pad within three seconds after the last time you touched the chosen function's command pad. Otherwise, cooking will start automatically in three seconds.

To increase cooking time by 7%:

TOUCH



YOU SEE

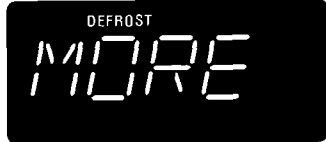

(example for defrost)

To decrease cooking time by 7%:

TOUCH



a second time

YOU SEE



CARING FOR YOUR MICROWAVE OVEN

To make sure your microwave oven looks good and works well for a long time, you should maintain it properly. For proper care, please follow these instructions carefully.

For interior surfaces: Wash often with warm, sudsy water and a sponge or soft cloth. Use only mild, nonabrasive soaps or a mild detergent. Be sure to keep the areas clean where the door and oven frame touch when closed. Wipe well with clean water. Over time, stains can occur on the surfaces as the result of food particles spattering during cooking. This is normal.

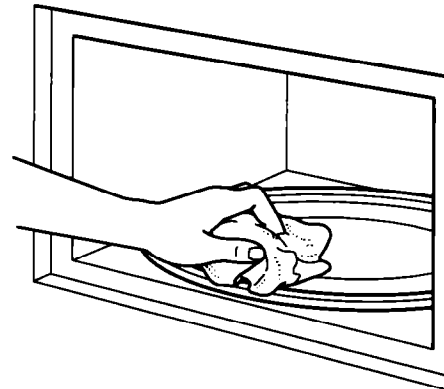

For stubborn soil, boil a cup of water in the oven for 2 or 3 minutes. Steam will soften the soil. To get rid of odors inside the oven, boil a cup of water with lemon juice or vinegar.

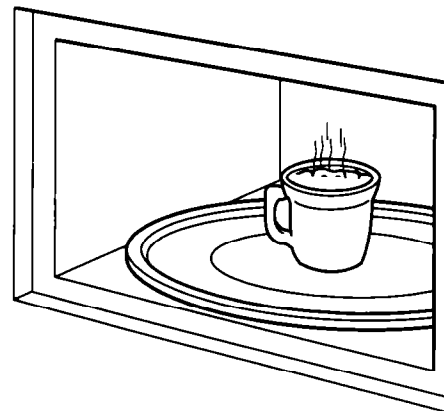

For exterior surfaces and control panel: Use a soft cloth with spray glass cleaner. Apply the spray glass cleaner to the soft cloth; do not spray directly on the oven.

NOTE: Abrasive cleansers, steel-wool pads, gritty wash cloths, some paper towels, etc., can damage the control panel and the interior and exterior oven surfaces.

To clean turntable and turntable support, wash in mild, sudsy water; for heavily soiled areas use a mild cleanser and scouring sponge. The turntable and turntable support are dishwasher-safe.

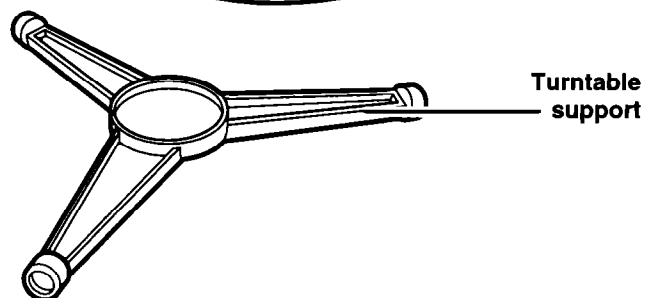
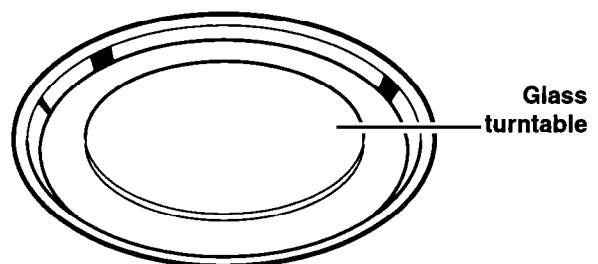

COOKING GUIDE

REHEATING CHART

Times are approximate and may need to be adjusted to individual taste.

NOTE: See "Using auto reheat" in the "Using Your Microwave Oven" section for instructions on how to reheat without cooking time and cook power.

ITEM	STARTING TEMPERATURE	MICROWAVE TIME	PROCEDURE
Plate of Food 1 serving of meat 2 servings of vegetables	Room temp. Refrigerated	MEDIUM - HIGH (70%) 1½ - 2¾ min. 2¾-4 min.	Meaty portion and bulky vegetables to outside. Cover with wax paper.
Meat (Chicken pieces, chops, hamburgers, meat loaf slices) 1 serving 2 servings	Refrigerated Refrigerated	MEDIUM - HIGH (70%) 1-2 min. 2-4 min.	Cover loosely with wax paper.
Meat Slices (Beef, ham, pork, turkey) 1 or more servings	Room temp. Refrigerated	MEDIUM (50%) 1-1¾ min. per serving 1½-2½ min. per serving	Cover with gravy or wax paper. Check after 30 sec. per serving.
Stirrable Casseroles and Main Dishes 1 serving 2 servings 4-6 servings	Refrigerated Refrigerated Refrigerated	HIGH (100%) 2¾-3½ min. 5-6¾ min. 9-10 min.	Cover with plastic wrap. Stir after half the time.
Non-stirrable Casseroles and Main Dishes 1 serving 2 servings 4-6 servings	Refrigerated Refrigerated Refrigerated	MEDIUM (50%) 4½-7½ min. 7½-11 min. 12-15 min.	Cover with wax paper.
Soup, Cream 1 cup 1 can (10¾ oz.)	Refrigerated Room temp.	MEDIUM (50%) 2-5½ min. 5-7½ min.	Cover. Stir after half the time.
Soup, Clear 1 cup 1 can (10¾ oz.)	Refrigerated Room temp.	HIGH (100%) 2-3 min. 3½-7 min.	Cover. Stir after half the time.
Pizza 1 slice 1 slice 2 slices 2 slices	Room temp. Refrigerated Room temp. Refrigerated	HIGH (100%) 15-25 sec. 25-35 sec. 25-35 sec. 55-60 sec.	Place on paper towel on microwave-safe rack.
Vegetables 1 serving 2 servings	Refrigerated Refrigerated	HIGH (100%) ¾-1¼ min. 1½-2 min.	Cover. Stir after half the time.
Baked Potato 1 2	Refrigerated Refrigerated	HIGH (100%) 1-2½ min. 2½ -3 min.	Cut potato lengthwise and then several times crosswise. Cover with wax paper.

continued on next page

REHEATING CHART (cont.)

ITEM	STARTING TEMPERATURE	MICROWAVE TIME	PROCEDURE
Breads (Dinner or breakfast roll)		HIGH (100%)	Wrap single roll, bagel, or muffin in paper towel. To reheat several, line plate with paper towel; cover with another paper towel.
1 roll	Room temp.	12-15 sec.	
2 rolls	Room temp.	15-20 sec.	
4 rolls	Room temp.	25-30 sec.	
Pie		HIGH (100%)	Place on microwave-safe dish. Do not cover.
1 slice	Refrigerated	30-45 sec.	
2 slices	Refrigerated	1-1½ min.	

After reheating, food should be very hot – 165° F. If possible, stir food, cover, and allow to stand 2 to 3 minutes before serving.

MICROWAVE COOKING CHART

Times are approximate and may need to be adjusted to individual taste.

NOTE: See “Using auto cook” in the “Using Your Microwave Oven” section for instructions on how to cook without cooking time and cook power.

Meat roasting chart

CUT	COOKING PREPARATION	MICROWAVE PROCEDURE	INTERNAL TEMP. AT REMOVAL	INTERNAL TEMP. AFTER STANDING
Beef				
Chuck or Pot Roast (cook in ½ cup liquid) (2-3 lbs.)	Large covered casserole. Turn over halfway through cooking time.	MEDIUM (50%)	150° F	160° F
Without vegetables		21-24 min. per lb.		
With 3-4 cups cut-up vegetables		27-30 min. per lb.		
Eye of Round (2-3 lbs.)	Rack. Cover with plastic wrap. Turn over halfway through cooking time.	MEDIUM (50%)		
		Rare: 5-8 min. per lb.	120° F	130° F
		Med: 7-10 min. per lb.	135° F	145° F
		Well: 9-11 min. per lb.	150° F	160° F
Ground Meat (to brown for casserole)	Casserole. Cover with plastic wrap. Stir halfway through cooking time.	HIGH (100%)		
		3½ - 5 min. per lb.	155° F	160° F
Hamburgers (¼ lb. each)	Rack. Cover with wax paper. Turn over halfway through cooking time.	HIGH (100%)		
2 patties		2¼ - 3½ min.		
4 patties		3½ - 5 min.		
Pork				
Loin Roast	Meat roasting rack. Cover with plastic wrap.	MEDIUM - HIGH (70%)	160° F	170° F
		7-11 min. per lb.		

Meat roasting chart (cont.)

CUT	COOKING PREPARATION	MICROWAVE PROCEDURE	INTERNAL TEMP. AT REMOVAL	INTERNAL TEMP. AFTER STANDING
Boneless	Turn over halfway through cooking time.	MEDIUM (50%) 12-14 min. per lb.	160° F	170° F
Bacon 2 slices 4 slices 6 slices	Place bacon between paper towels on paper plate or on a rack.	HIGH (100%) 1½ - 2 min. 2½ - 3½ min. 3½ - 4½ min.		
Smoked Ham Canned Butt Shank	Casserole. Cover with plastic wrap. Turn over halfway through cooking time. Drain and shield if necessary.	MEDIUM (50%) 5-8 min. per lb. 8-11 min. per lb.	130° F 130° F	135° F 135° F

Poultry roasting chart

CUT	COOKING PREPARATION	MICROWAVE PROCEDURE	INTERNAL TEMP. AT REMOVAL	INTERNAL TEMP. AFTER STANDING
Chicken Whole	Breast side down on rack. Cover with plastic wrap. Turn over halfway through cooking time.	MEDIUM - HIGH (70%) 5-8 min. per lb.	170° F	180° F
Pieces Bone-in Boneless	Rack. Cover with plastic wrap. Turn over halfway through cooking time.	HIGH (100%) 5-7½ min. per lb. 4-7 min. per lb.	170° F 160° F	180° F 170° F
Turkey Whole (up to 10 lbs.)	Breast side down on rack. Cover with plastic wrap. Turn over halfway through cooking time.	MEDIUM (50%) 10-14 min. per lb.	170° F	180° F
Breast Bone-in Boneless	Rack. Cover with plastic wrap. Turn over halfway through cooking time.	MEDIUM (50%) 11-15 min. per lb. 14-18 min. per lb.	160° F 160° F	170° F 170° F

Fish and seafood cooking chart

CUT	COOKING PREPARATION	MICROWAVE PROCEDURE	STANDING TIME
Fillets	Pie plate or casserole. Cover with plastic wrap.	POWER LEVEL (80%) 4-6 min. per lb.	3 min.
Steaks	Pie plate or casserole. Cover with plastic wrap. Turn over halfway through cooking time.	POWER LEVEL (80%) 5-7 min. per lb.	3 min.

continued on next page

Fish and seafood cooking chart (cont.)

CUT	COOKING PREPARATION	MICROWAVE PROCEDURE	STANDING TIME
Shrimp & Scallops	Pie plate or casserole. Cover with plastic wrap. Turn over halfway through cooking time.	POWER LEVEL (80%) 4-6 min. per lb.	1-2 min.

Vegetable cooking chart

VEGETABLE	AMOUNT	COOKING PROCEDURE	MICROWAVE TIME AT HIGH (100%)	STANDING TIME, COVERED
Artichokes Fresh	2 medium	Trim and rinse. 2-qt. casserole. 2 tbsp. water. Cover with plastic wrap.	5-8 min.	5 min.
Asparagus Fresh Spears	1 lb.	2-qt. casserole. 2 tbsp. water. Cover. Rearrange after 3 min.	4-7 min.	2 min.
Frozen Spears	10-oz. pkg.	1-qt. casserole. 1 tbsp. water. Cover. Rearrange after 3 min.	7-9 min.	2 min.
Beans Fresh, Green and Wax	1 lb.	1½-inch pieces. 2-qt. casserole. ¼ cup water. Cover. Stir twice.	9-13 min.	2 min.
Frozen, Green	10-oz. pkg.	1-qt. casserole. 1 tbsp. water. Cover. Stir after 3 min.	5-7 min.	2 min.
Frozen, Lima	10-oz. pkg.	1-qt. casserole. 1 tbsp. water. Cover. Stir once.	6-9 min.	2 min.
Beets Fresh, Whole	5 medium	Wash. Leave 1 inch of tops. 2-qt. casserole. ¼ cup water. Cover. Stir every 5 min.	12-18 min.	3 min.
Broccoli Fresh, Spears	1 lb.	Wash. 2-qt. casserole. Add no water. Cover. Rearrange after 3 min. Uncover during stand.	6-8 min.	3 min., uncovered
Fresh, Pieces	1 lb.	Wash. 2-qt. casserole. Add no water. Cover. Stir after 3 min. Uncover during stand.	5-7 min.	2 min., uncovered
Frozen, Spears, Cuts, Chopped	10-oz. pkg.	1-qt. casserole. 2 tbsp. water. Cover. Stir after 3 min. Uncover during stand.	5-7 min.	2 min., uncovered

Vegetable cooking chart (cont.)

VEGETABLE	AMOUNT	COOKING PROCEDURE	MICROWAVE TIME AT HIGH (100%)	STANDING TIME, COVERED
Brussels Sprouts				
Fresh	4 cups	2-qt. casserole. ¼ cup water. Cover. Stir after 2 min.	6-8 min.	3 min.
Frozen	10-oz. pkg.	1-qt. casserole. 2 tbsp. water. Cover. Stir after 3 min.	6-8 min.	3 min.
Cabbage				
Shredded	1 lb.	2-qt. casserole. 2 tbsp. water. Cover. Stir after 4 min.	8-12 min.	2 min.
Wedges	1 lb.	2-qt. casserole. 2 tbsp. water. Cover. Rearrange after 5 min.	12-14 min.	3 min.
Carrots				
Fresh, Slices	2 cups	1-qt. casserole. 2 tbsp. water. Cover. Stir after 3 min.	5-6 min.	3 min.
Frozen, Slices	2 cups	1-qt. casserole. 1 tbsp. water. Cover. Stir after 3 min.	5-7 min.	3 min.
Cauliflower				
Fresh, Flowerets	2 cups	1-qt. casserole. 1 tbsp. water. Cover. Stir after 2 min.	3-5 min.	2 min.
Fresh, Whole	1½ lbs.	Remove leaves and core center. 2-qt. casserole. 2 tbsp. water. Cover.	7-9 min.	3 min.
Frozen, Flowerets	10-oz. pkg.	1-qt. casserole. 1 tbsp. water. Cover. Stir after 3 min.	4-6 min.	2 min.
Corn				
Fresh, on Cob	2 ears	9-in. pie plate. 2 tbsp. water. Cover. Rearrange after 4 min.	6-9 min.	5 min.
	4 ears	2-qt. oval or rectangular casserole. ¼ cup water. Cover.	12-14 min.	5 min.
Frozen, on Cob	2 ears	9-in. pie plate. 2 tbsp. water. Cover. Rearrange after 4 min.	6-8 min.	5 min.
	4 ears	2-qt. oval or rectangular casserole. ¼ cup water. Cover.	10-12 min.	5 min.
Frozen, Whole Kernel	10-oz. pkg.	1-qt. casserole. 1 tbsp. water. Cover. Stir after 2 min.	4-6 min.	2 min.
Okra				
Fresh, Whole	¾ lb.	1½ - 2-qt. casserole. ¼ cup water. Cover. Stir after 3 min.	8-10 min.	3 min.
Frozen, Whole or Slices	10-oz. pkg.	1½ - 2-qt. casserole. 2 tbsp. water. Cover. Stir after 3 min.	6-8 min.	3 min.
Peas, Black-Eyed				
Frozen	10-oz. pkg.	2-qt. casserole. ¼ cup water. Cover. Stir after 4 min.	8-10 min.	3 min.

continued on next page

Vegetable cooking chart (cont.)

VEGETABLE	AMOUNT	COOKING PROCEDURE	MICROWAVE TIME AT HIGH (100%)	STANDING TIME, COVERED
Peas, Green				
Fresh	2 cups	1-qt. casserole. ¼ cup water. Cover. Stir after 3 min.	4-6 min.	3 min.
Frozen	10-oz. pkg.	1-qt. casserole. 1 tbsp. water. Cover. Stir after 3 min.	6-8 min.	3 min.
Potatoes				
Baked	2 medium 4 medium	Pierce. Place on paper towels. Turn over, rearrange at ½ time. Let stand, foil wrapped.	7-9 min. 13-16 min.	5-10 min. 5-10 min.
Boiled	4 medium	Peel and quarter potatoes. 2-qt. casserole. Cover. Stir after 5 min.	9-12 min.	3 min.
Spinach				
Fresh	1 lb.	Wash and trim. Add no water. 3-qt. casserole. Cover. Stir after 3 min.	5-7 min.	2 min.
Frozen, Leaf or Chopped	10-oz. pkg.	1-qt. casserole. Add no water. Cover. Stir after 3 min.	6-8 min.	2 min.
Squash				
Fresh, Acorn	1 whole	Pierce. Place on paper towel. Turn over after 4 min.	7-10 min.	5 min.
Fresh, Sliced Zucchini	2 cups	1-qt. casserole. Add no water. Cover. Stir after 2 min.	2-4 min.	1 min.
Frozen, Mashed	10-oz. pkg.	1-qt. casserole. Add no water. Cover. Break apart and stir after 3 min.	6-8 min.	2 min.
Sweet Potatoes				
Baked	2 medium 4 medium	Pierce. Place on paper towels. Turn over, rearrange after 5 min.	5-9 min. 10-13 min.	5 min. 5 min.
Tomatoes				
Fresh	2 medium 4 medium	Halve tomatoes. Round dish. Cover. Rearrange once.	2-4 min. 5-8 min.	2 min. 2 min.
Canned Vegetables	15-16 oz.	1-qt. casserole. Drain all but 2 tbsp. liquid. Stir once.	2-4 min.	2 min.

MICROWAVE COOKING TIPS

Amount of food

- **If you increase or decrease** the amount of food you prepare, the time it takes to cook that food will also change. For example, if you double a recipe, add a little more than half the original cooking time. Check for doneness and, if necessary, add more time in small increments.

Starting temperature of food

- **The lower the temperature** of the food being put into the microwave oven, the longer it takes to cook. Food at room temperature will be reheated more quickly than food at refrigerator temperature.

Composition of food

- **Food with a lot of fat and sugar** will be heated faster than food containing a lot of water. Fat and sugar will also reach a higher temperature than water in the cooking process.
- **The more dense the food**, the longer it takes to heat. "Very dense" food like meat takes longer to reheat than lighter, more porous food like sponge cakes.

Size and shape

- **Smaller pieces of food** will cook faster than larger pieces. Also, same-shaped pieces cook more evenly than different-shaped pieces.
- **With foods that have different thicknesses**, the thinner parts will cook faster than the thicker parts. **Place** the thinner parts of chicken wings and legs in the center of the dish.

Stirring, turning foods

- **Stirring and turning foods** spreads heat quickly to the center of the dish and avoids overcooking at the outer edges of the food.

Covering food

Cover food to:

- **Reduce** splattering
- **Shorten** cooking times
- **Keep** food moist

You can use any covering that lets microwaves pass through.

Releasing pressure in foods

- **Several foods** (for example: baked potatoes, sausages, egg yolks, and some fruits) are tightly covered by a skin or membrane. Steam can build up under the membrane during cooking, causing the food to burst. To relieve the pressure and to prevent bursting, **pierce** these foods before cooking with a fork, cocktail pick, or toothpick.

Using standing time

- **Always allow food to stand** after cooking. Standing time after defrosting and cooking allows the temperature to evenly spread throughout the food, improving the cooking results.
- **The length of the standing time** depends on how much food you are cooking and how dense it is. Sometimes it can be as short as the time it takes you to remove the food from the oven and take it to the serving table. However, with larger, denser food, the standing time may be as long as 10 minutes.

MICROWAVE COOKING TIPS (CONT.)

Arranging food

For best results, place food evenly on the plate.

You can do this in several ways:

- **If you are cooking several items of the same food**, such as baked potatoes, **place** them in a ring pattern for uniform cooking.
- **When cooking foods of uneven shapes or thickness, such as chicken breasts, place** the smaller or thinner area of the food towards the center of the dish where it will be heated last.
- **Layer thin slices of meat** on top of each other.
- **When you cook or reheat whole fish, score** the skin – this prevents cracking. Shield the tail and head of whole fish with small pieces of foil to prevent overcooking. When using foil, make sure it doesn't touch the sides of the oven.
- **Do not** let food or a container touch the top or sides of the oven. This will prevent possible arcing.

Using aluminum foil

Metal containers should not be used in a microwave oven. There are, however, some exceptions. If you have purchased food which is prepackaged in an aluminum foil container, then refer to the instructions on the package. When using aluminum foil containers, cooking times may be longer because microwaves will only penetrate the top of the food.

If you use aluminum containers without package instructions, follow these guidelines:

- **Place** the container in a glass bowl and add some water so that it covers the bottom of the container, not more than ¼ inch high. This ensures even heating of the container bottom.
- **Always remove** the lid to avoid damage to the oven.
- **Use only** undamaged containers.
- **Do not use** containers taller than ¾ inch.
- **Container must be** half filled.
- **To avoid arcing**, there must be a minimum ¼ inch between the aluminum container and the walls of the oven and also between two aluminum containers.
- **Always place** the container on the turntable.
- **Reheating food** in aluminum foil containers usually takes up to double the time compared to reheating in plastic, glass, china, or paper containers. The time when food is ready will vary depending upon the type of container you use.
- **Let food stand** for 2-3 minutes after heating so that heat is spread evenly throughout container.

Cooking you should not do in your microwave oven

- **Do not** do canning of foods in the oven. Closed glass jars may explode, resulting in damage to the oven or possible personal injury.
- **Do not** use the microwave oven to sterilize objects (baby bottles, etc.). It is difficult to keep the oven at the high temperature needed for safe sterilization.

QUESTIONS AND ANSWERS

QUESTIONS	ANSWERS
Can I operate my microwave oven without the turntable or turn the turntable over to hold a large dish?	No. If you remove or turn over the turntable, you will get poor cooking results. Dishes used in your oven must fit on the turntable.
Can I use a rack in my microwave oven so that I may reheat or cook on two levels at a time?	You can use a rack only if the rack is supplied with your microwave oven. If you use a rack not supplied with the microwave oven, you can get poor cooking performance and/or arcing.
Can I use either metal or aluminum pans in my microwave oven?	You can use aluminum foil for shielding (use small, flat pieces), small skewers, and shallow foil trays (if tray is not taller than ¾ inch deep and half filled with food to absorb microwave energy). Never allow metal to touch walls or door. (For more information, see "Using aluminum foil" in the "Microwave cooking tips" section.
Is it normal for the turntable to turn in either direction?	Yes. The turntable rotates clockwise or counter-clockwise, depending on the rotation of the motor when the cooking cycle begins.
Sometimes the door of my microwave oven appears wavy. Is this normal?	This appearance is normal and does not affect the operation of your oven.
What are the humming noises that I hear when my microwave oven is operating?	You hear the sound of the transformer when the magnetron tube cycles on.
Why does the dish become hot when I microwave food in it? I thought that this should not happen.	As the food becomes hot it will conduct the heat to the dish. Be prepared to use hot pads to remove food after cooking.
What does "standing time" mean?	"Standing time" means that food should be removed from the oven and covered for additional time to allow it to finish cooking. This frees the oven for other cooking.
Why does steam come out of the air exhaust vent?	Steam is normally produced during cooking. The microwave oven has been designed to vent this steam out the rear vents.
Can I pop popcorn in my microwave oven? How do I get the best results?	Yes. Pop packaged microwave popcorn following manufacturer's guidelines or use the preset Popcorn pad. Do not use regular paper bags. Use the "listening test" by stopping the oven as soon as the popping slows to a "pop" every one or two seconds. Do not repop unpopped kernels. Do not pop popcorn in glass utensils.

TROUBLESHOOTING

Most cooking problems often are caused by little things you can find and fix without tools of any kind. Check the lists below and on the next page before calling for assistance or service. If you still need help, see the “Requesting Assistance or Service” section.

MICROWAVE OVEN DOES NOT WORK

PROBLEM	CAUSE
Nothing works.	<ul style="list-style-type: none">● The power supply cord is not plugged into a live circuit with the proper voltage. (See the “Electrical requirements” in the “Installation Instructions” section and “Electrical connection” in the “Getting to Know” section.)● A household fuse has blown or a circuit breaker has tripped.● The electric company has had a power failure.
The microwave oven will not run.	<ul style="list-style-type: none">● You are using the oven as a timer. Touch the off/cancel pad to cancel the minute timer.● The door is not firmly closed and latched.● You did not touch the start/enter pad.● You did not follow directions exactly.● An operation that you set earlier is still running. Touch the off/cancel pad to cancel that operation.

COOKING TIMES

PROBLEM	CAUSE
Microwave cooking times seem too long.	<ul style="list-style-type: none">● The electric supply to your home or wall outlets is low or lower than normal. Your electric company can tell you if the line voltage is low. Your electrician or service technician can tell you if the outlet voltage is low.● The cook power is not at the recommended setting. Check the “Microwave cooking chart” section.● You have not allowed enough cooking time for the amount of food being cooked. Larger amounts of food need longer cooking times.
The display shows a time counting down but the oven is not cooking.	<ul style="list-style-type: none">● You have set the controls as a minute timer. Touch the off/cancel pad to cancel the minute timer.

TURNTABLE

PROBLEM	CAUSE
The turntable will not turn.	<ul style="list-style-type: none"> ● The turntable is not correctly in place. It should be correct-side up and sitting firmly on the center shaft. ● The support is not operating correctly. Remove the turntable and restart the oven. If the support still does not move, call an authorized Whirlpool service technician for repair. Cooking without the turntable can give you poor results.

TONES

PROBLEM	CAUSE
You do not hear the programming or end-of-cycle tone.	<ul style="list-style-type: none"> ● You have not entered the correct command. ● You have turned off the tone. See "Audible signals" in the "Control panel features" section.

FAN PROBLEMS

PROBLEM	CAUSE
The fan seems to be running slower than usual.	<ul style="list-style-type: none"> ● The oven has been stored in a cold area. The fan will run slower until the oven warms up to normal room temperature.

DISPLAY MESSAGES

PROBLEM	CAUSE
The display is flashing "88:88."	<ul style="list-style-type: none"> ● There has been a power interruption. Reset the clock. (See "Setting the clock" in the "Getting to Know" section.)

If none of these items are causing your problem, see the "Requesting Assistance or Service" section.

REQUESTING ASSISTANCE OR SERVICE

To avoid unnecessary service calls, please check the "Troubleshooting" section. It may save you the cost of a service call. If you still need help, follow the instructions below.

IF YOU NEED ASSISTANCE OR SERVICE

Call the Whirlpool Consumer Assistance Center toll free at 1-800-253-1301. Our consultants are available to assist you.



When calling:

Please know the purchase date, and the complete model and serial number of your appliance (see the "A Note to You" section). This information will help us better respond to your request.

Our consultants provide assistance with:

- Features and specifications on our full line of appliances
- Installation information
- Use and maintenance procedures

- Accessory and repair parts sales
- Do-it-yourself repair help
- Specialized customer assistance (Spanish speaking, hearing impaired, limited vision, etc.)
- Referrals to local dealers, service companies, and repair parts distributors

Whirlpool service technicians are trained to fulfill the product warranty and provide after-warranty service, anywhere in the United States.

To locate the authorized Whirlpool service company in your area, you can also look in your telephone directory Yellow Pages.

IF YOU NEED REPLACEMENT PARTS

If you need to order replacement parts, we recommend that you only use FSP® factory authorized parts. FSP replacement parts will fit right and work right, because they are made to the same exacting specifications used to build every new WHIRLPOOL® appliance.

To locate FSP replacement parts in your area, call our Consumer Assistance Center telephone number or your nearest authorized service center.

FOR FURTHER ASSISTANCE

If you need further assistance, you can write to Whirlpool with any questions or concerns at:

Whirlpool Brand Home Appliances
Consumer Assistance Center
c/o Correspondence Dept.
2000 North M-63
Benton Harbor, MI 49022-2692

Please include a daytime phone number in your correspondence.

If the dealer, authorized servicer, and Whirlpool have failed to resolve your problem, you can contact the Major Appliance Consumer Action Program (MACAP). MACAP is a group of independent consumer experts that voice consumer views at the highest levels of the major appliance industry. MACAP will in turn inform us of your action.

Major Appliance Consumer Action Program
20 North Wacker Drive
Chicago, IL 60606

INDEX

This index is alphabetical. It contains all the topics included in this manual, along with the page(s) on which you can find each topic.

TOPIC	PAGE	TOPIC	PAGE
ALUMINUM FOIL	44	ELECTRICAL REQUIREMENTS	6, 10
AUDIBLE SIGNALS	13	ERROR SIGNALS	13
BUILT-IN KITS	14	GROUNDING INSTRUCTIONS	6
CARING FOR YOUR MICROWAVE OVEN	36	HOW YOUR MICROWAVE OVEN WORKS	7, 8
CHARTS		INSTALLATION INSTRUCTIONS	5
Auto cook	24	PARTS AND FEATURES	
Auto defrost	27	Cooking guide label	11
Auto reheat	34	Door open button	11
Fish and seafood cooking	39	Door safety lock system	11
Meat roasting	38	Light	11
Popcorn	28	Magnetron	7, 45
Poultry roasting	39	Model and serial number plate	11
Reheating	37	Turntable	7, 10, 11, 36, 45
Vegetable cooking	40	Vents (exhaust & air intake openings)	5
CONTROL PANEL	12, 13	Window	11
Add minute	34	QUESTIONS AND ANSWERS	45
Adding or subtracting cooking time	35	RACK	45
Audible signals	13	RADIO INTERFERENCE	8
Auto cook	23	REQUESTING ASSISTANCE OR SERVICE	48
Auto defrost	25	SAFETY	3, 4, 9, 10
Auto reheat	33	STANDING TIME	28, 43, 45
Baked potato	32	TESTING YOUR DINNERWARE OR COOKWARE	9
Beverage	30	TESTING YOUR MICROWAVE OVEN	8
Clock set	14	TIPS	
Cooking at different cook powers	18	Baked potato	32
Cooking at high cook power	17	Cooking	8, 43
Cooking in stages	21	Defrosting	26, 28
Cook power	18, 19, 21, 22	Dinner plate	31
Cook time	17, 19, 21	Popcorn	28
Dinner plate	31	TROUBLESHOOTING	46, 47
Hold time	20	WARRANTY	52
Interrupting cooking	13		
Learning feature	13		
Minute timer	16		
Number pads	12		
Off/cancel	13		
Popcorn	28		
Safety lock	13		
Start/enter	13		

WARRANTY

WHIRLPOOL® MICROWAVE OVEN

LENGTH OF WARRANTY	WHIRLPOOL WILL PAY FOR
FULL ONE-YEAR WARRANTY FROM DATE OF PURCHASE	FSP® replacement parts and repair labor to correct defects in materials or workmanship. Service must be provided by an authorized Whirlpool service company.
LIMITED FOUR-YEAR WARRANTY SECOND THROUGH FIFTH YEAR FROM DATE OF PURCHASE	FSP replacement magnetron tube on microwave ovens if defective in materials or workmanship.
WHIRLPOOL WILL NOT PAY FOR	
<p>A. Service calls to:</p> <ol style="list-style-type: none"> 1. Correct the installation of your microwave oven. 2. Instruct you how to use your microwave oven. 3. Replace house fuses or correct house wiring. 4. Replace owner-accessible light bulbs. <p>B. Repairs when your microwave oven is used in other than normal, single-family household use.</p> <p>C. In-home service. Your microwave oven must be taken to an authorized Whirlpool service company, except when your microwave oven is installed over an approved Whirlpool oven using an approved built-in kit. (See the "Built-In kits" section for a list of approved built-in kits.)</p> <p>D. Damage to your microwave oven caused by accident, misuse, fire, flood, acts of God, or use of products not approved by Whirlpool.</p> <p>E. Any labor costs during limited warranty.</p> <p>F. Repairs to parts or systems caused by unauthorized modifications made to the appliance.</p>	

3/96

WHIRLPOOL CORPORATION SHALL NOT BE LIABLE FOR INCIDENTAL OR CONSEQUENTIAL DAMAGES. Some states do not allow the exclusion or limitation of incidental or consequential damages, so this exclusion or limitation may not apply to you. This warranty gives you specific legal rights, and you may also have other rights which vary from state to state.

Outside the United States, a different warranty may apply. For details, please contact your authorized Whirlpool dealer.

If you need service, first see the "Troubleshooting" section of this book. After checking "Troubleshooting," additional help can be found by checking the "Requesting Assistance or Service" section or by calling our Consumer Assistance Center telephone number, **1-800-253-1301**, from anywhere in the U.S.A.